

ROHS  
Compliant

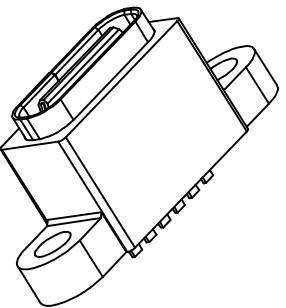

3D VIEW

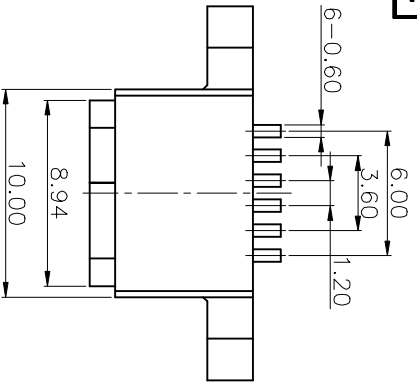
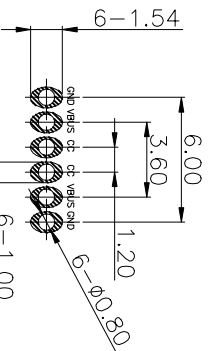
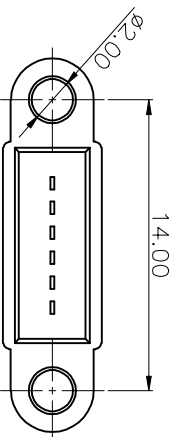
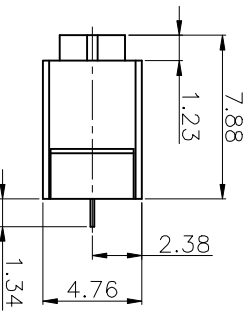
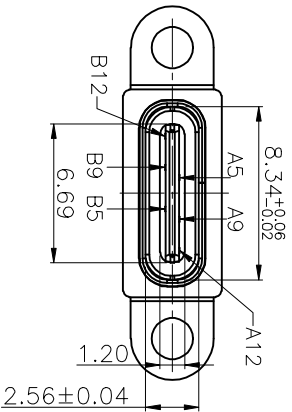

RECOMMENDED P.C.B. LAYOUT  
TOP VIEW (TOLERANCE:±0.05)

- SPECIFICATIONS:
1. CURRENT RATING: 3.0A MAX
  2. DIELECTRIC WITHSTAND VOLTAGE: 100VAC
  3. TEMPERATURE RANGE: -30 °C ~ 85 °C
  4. CONTACT RESISTANCE: 40 MILLIONHM MAX
  5. INSULATION RESISTANCE: 100 MEGOHMS MIN.
  6. INSERTION FORCE : 5N~20N
  7. UNMATING FORCE: 8N~20N
  8. DURABILITY:10,000 CYCLES
  9. WATER PROOFNESS:THIS PRODUCT IS BASED ON IPX8.

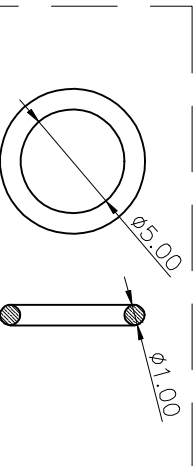
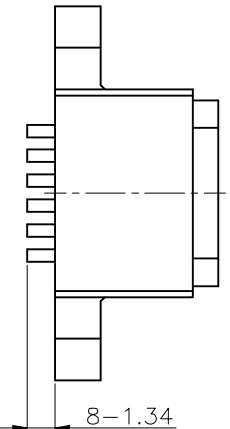

注：防水圈是圆形截面，直径为1.0mm的硅胶圈，防水圈挤压量，由1.0mm挤压到0.5mm ~ 0.6mm, 防水效果好

NO.	DESCRIPTION	MATERIAL	REMARKS	QTY
1	CONTACT	PHOSPHOR BRONZE	AU/NI PLATING T=0.2mm	6
2	HOUSING_1	PA10T	COLOR BLACK	1
3	HOUSING_2	PA10T	COLOR BLACK	1
4	SHELL_1	SUS301	NI PLATING T=0.25mm	1
5	SHELL_2	SUS301	NI PLATING T=0.20mm	1

结构设计注意：  
成品使用时，如有洗面奶泡沫、牙膏、洗手液、脏污液体，请在TYPE-C口外面再设计一层外壳，保护TYPE-C表面金手指不会被脏污覆盖。

PIN	SIGNAL NAME	PIN	SIGNAL NAME
A5	CC1	B12	GND
A9	VBUS	B9	VBUS
A12	GND	B5	CC2

**LZG**

LZG INDUSTRIAL CO., LTD

PART NAME WATERPROOF TYPE C 6PIN  
PART NO. ZB48018-06DBAP-A

TOLERANCE UNLESS OTHERWISE SPECIFIED: 0.00±0.1  
0.00±0.05

0.±2  
0.0±1  
0.00±0.5

UNIT: mm

DRAWING NO. ZB48018-06DBAP-A

DRAWING: 林生材  
CHECK: 李宏鑫  
APPROVAL: 郝进宝

DATE: 2020.02.18  
DATE: 2020.02.18  
DATE: 2020.02.18

SCALE 1:1  
MATERIAL \*  
DWG. NO.  
SHEET 1/1

F

E

D

C

B

A

4

3

2

1

F

E

D

C

B

A

4

3

2

1

ZONE	ECN. NO.	DESCRIPTION	DRAWING	DATE
A		INITIAL	林生材	2020.02.18