

RoHS
Compliant

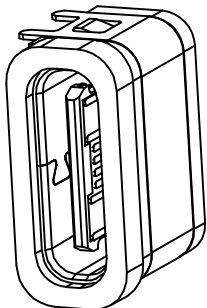

3D VIEW

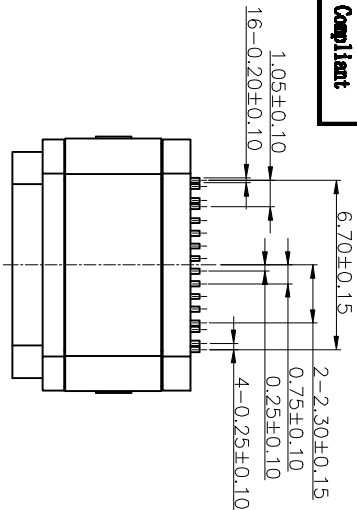
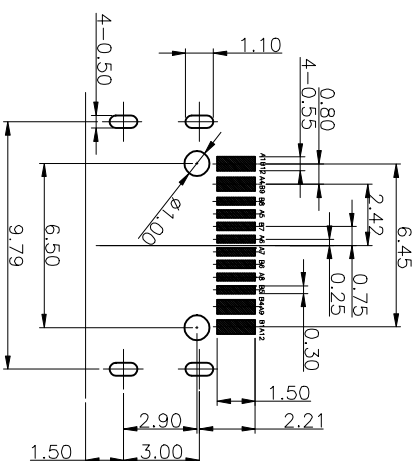
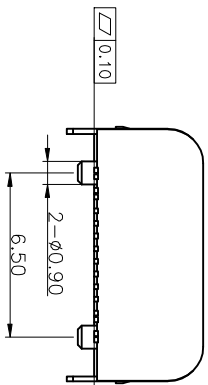
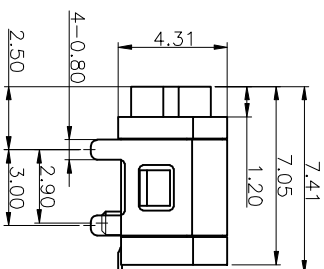
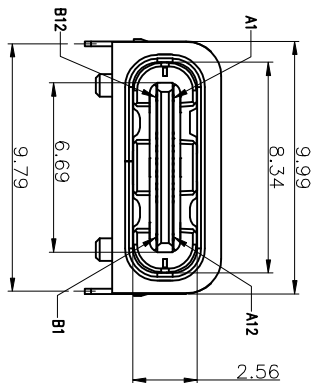
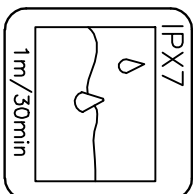

RECOMMENDED P.C.B. LAYOUT
TOLERANCE UNSPECIFIED ±0.05mm

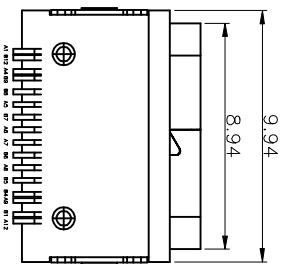

ZONE	E.C.N. NO.	DESCRIPTION	DRAWING	DATE
A		INITIAL	林生财	2020.02.18

- NOTES:
SPECIFICATIONS:
1. CURRENT RATING: 3.0A MAX
2. VOLTAGE: 100 VAC
3. TEMPERATURE RANGE: -30 °C ~ 85 °C
4. CONTACT RESISTANCE: 40 MILLIONHM MAX.
5. INSULATION RESISTANCE: 100 MEGOHMS MIN.
6. INSERTION FORCE : 5N~20N
7. UNMATING FORCE: 8N~20N
8. DURABILITY: 10,000 CYCLES
9. WATER PROOFNESS: THIS PRODUCT IS BASED ON IPX7.

NO.	DESCRIPTION	MATERIAL	REMARKS	QTY
6	WATERPROOF RING	SILICONE	COLOR BLACK	1
5	SHELL	STAINLESS STEEL	NI Plated	1
4	SHIELDING PLATE	STAINLESS STEEL	NI Plated	1
3	CONTACT	COPPER ALLOY	TIN/Au/NI Plated	16
2	SHELL HOUSING	HIGH TEMPERATURE PLASTIC	COLOR BLACK	1
1	HOUSING	HIGH TEMPERATURE PLASTIC	COLOR BLACK	1

LZG INDUSTRIAL CO., LTD

PART NAME: WATERPROOF TYPE C 16PIN
PART NO.: ZB48007-16SBAP-A

TOLERANCE UNLESS OTHERWISE SPECIFIED: 0.00±0.3
0.00±0.2
0.000±0.1

UNIT: mm



DRAWING: CHECK: APPROVAL: DRAWING NO.

DATE: 2020.02.18
DATE: 2020.02.18
DATE: 2020.02.18

SCALE: 1:1
MATERIAL: *
DWG. NO.:
SHEET: 1/2

4 3 2 1 F E D C B A

ZONE	E.C.N. NO.	DESCRIPTION	DRAWING	DATE
A		INITIAL	林生财	2020.02.18

A1	GND	B12	GND
A4	VBUS	B9	VBUS
A5	CC1	B8	SBU2
A6	DP1	B7	DN2
A7	DN1	B6	DP2
A8	SBU1	B5	CC2
A9	VBUS	B4	VBUS
A12	GND	B1	GND
PIN	SIGNAL NAME	PIN	SIGNAL NAME

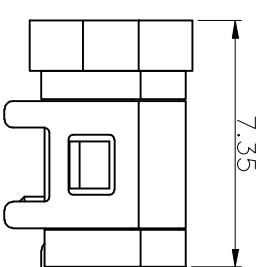
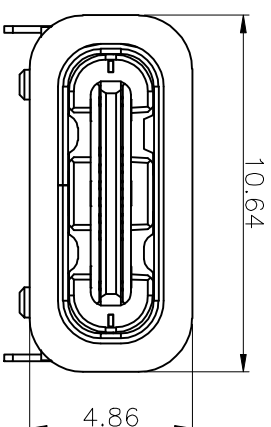

带防水圈示意图



LZG INDUSTRIAL CO., LTD

PART NAME WATERPROOF TYPE C 16PIN
PART NO. ZB48007-16SBAP-A

TOLERANCE UNLESS OTHERWISE SPECIFIED: 0.0±0.3
0.00±0.2
0.000±0.1

0.±2°
0.0±1°
0.00±0.5'

UNIT: mm

DRAWING: CHECK: APPROVAL: DRAWING NO.

林生财

李宏鑫

杨进宝

DATE: 2020.02.18

DATE: 2020.02.18

DATE: 2020.02.18

SCALE 1:1

MATERIAL *

DWG. NO.

2/2

F

E

D

C

B

A

4

3

2

1

4

3

2

1