

ROHS
Compliant

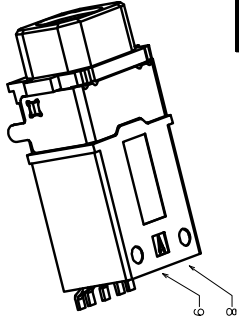

3D VIEW

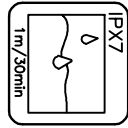
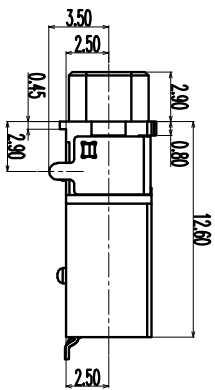
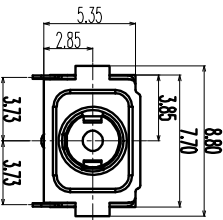
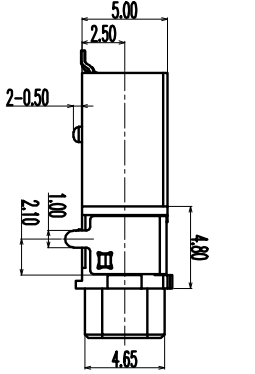
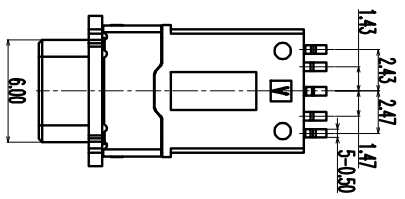

NOTES

1. CURRENT RATING: 0.5A / DC 12V.
2. CONTACT RESISTANCE: 50mΩ MAX.
3. INSULATION RESISTANCE: 100MΩ MIN.
4. DIELECTRIC WITHSTANDING: 500V AC MIN.
5. DURABILITY: 5000 CYCLES MIN.
6. CONNECTOR MATING FORCES: 3~30N.
7. CONNECTOR UNMATING FORCES: 3~30N×.
8. SALT SPRAY: 24HOUR
9. WATERPROOF LEVEL: IPX7.
10. OPERATING TEMPERATURE: -25°C TO +85°C.

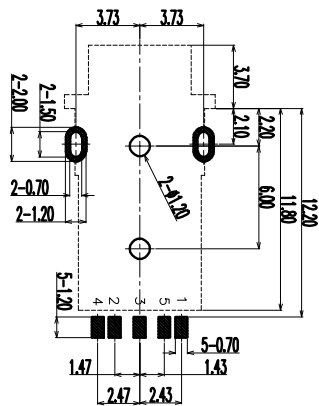

PCB LAYOUT (TOP VIEW)
TOLERANCE: ±0.05

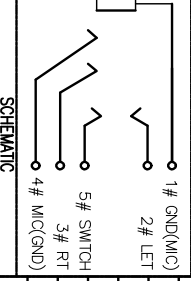
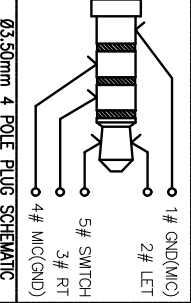
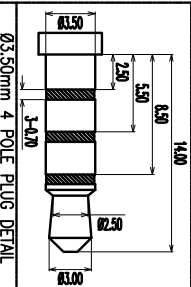
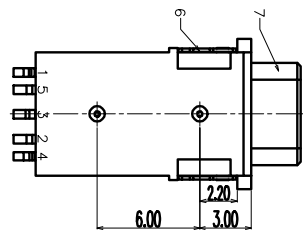

NO.	DESCRIPTION	MATERIAL	REMARKS	QTY
9	GLUE	EPOXY	COLOR BLACK	1
8	COVER	HIGH TEMPERATURE	COLOR BLACK	1
7	HOUSING	HIGH TEMPERATURE	COLOR BLACK	1
6	TERMINAL 6#	PHOSPHOR BRONZE	NICKEL UNDERPLATING OVERALL, GOLD FLASH PLATING	1
5	TERMINAL 5#	PHOSPHOR BRONZE	NICKEL UNDERPLATING OVERALL, GOLD FLASH PLATING	1
4	TERMINAL 4#	PHOSPHOR BRONZE	NICKEL UNDERPLATING OVERALL, GOLD FLASH PLATING	1
3	TERMINAL 3#	PHOSPHOR BRONZE	NICKEL UNDERPLATING OVERALL, GOLD FLASH PLATING	1
2	TERMINAL 2#	PHOSPHOR BRONZE	NICKEL UNDERPLATING OVERALL, GOLD FLASH PLATING	1
1	TERMINAL 1#	PHOSPHOR BRONZE	NICKEL UNDERPLATING OVERALL, GOLD FLASH PLATING	1

LZG INDUSTRIAL CO., LTD

WATERPROOF 03.5 PHONE JACK

TOLERANCE UNLESS OTHERWISE SPECIFIED: 0.000±0.10

0.0±0.25
0.00±0.20
0.0±1°
0.00±0.5°

UNIT: mm

DRAWING NO. ZB23002-06SBAP-A

ZONE	EC.N. NO.	DESCRIPTION	DRAWING	DATE
A	INITIAL		林生财	2020.02.18

DRAWING:	DATE:	SCALE:
林生财	2020.02.18	1:1

CHECK:	DATE:	MATERIAL:
李宏鑫	2020.02.18	*

APPROVAL:	DATE:	DWG. NO.
柳进宝	2020.02.18	

DRAWING NO.	SHEET
ZB23002-06SBAP-A	1/1